

PHILIPS

H7 CANbus

H7-LED

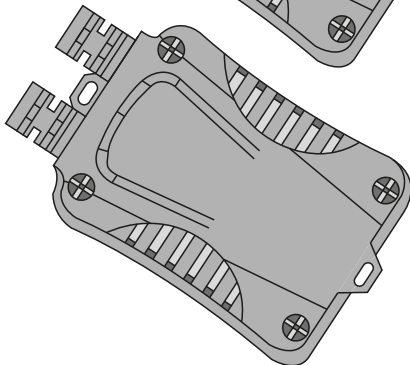
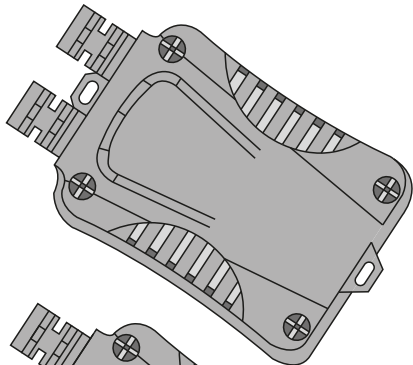

1

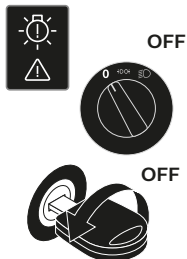

2

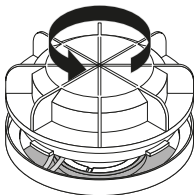

3A - Kunststoff-Deckel
Hard Cover

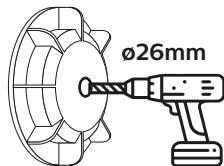

3B - Gummi-Kappe
Soft Cover

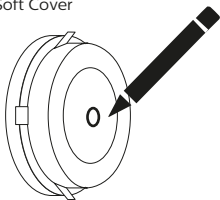

25mm Kreis zeichnen
Draw 25mm circle

3B - Gummi-Kappe
Soft Cover

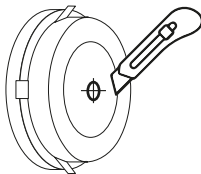

**Gummi mit Messer innerhalb
des Kreises einschneiden**
Make a cross with knife

3B - Gummi-Kappe
Soft Cover

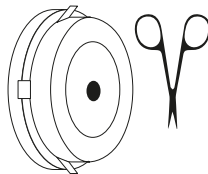

**25mm Kreis mit
Schere ausschneiden**
Cut with nail scissors

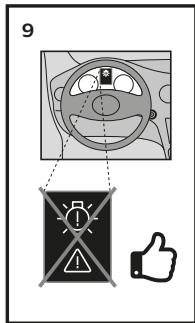
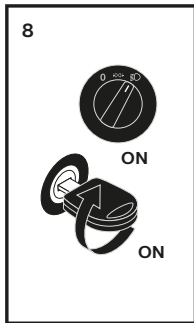
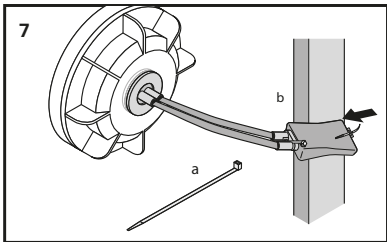
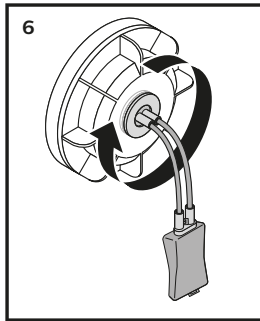
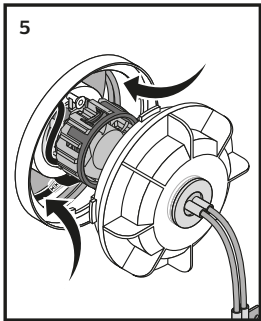
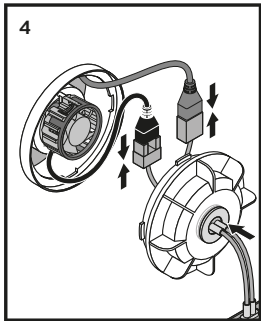



**Lumileds ist der Garantiegeber für dieses Produkt.
Philips und das Philips Wappen sind eingetragene Marken von
Koninklijke Philips N.V. und werden unter Lizenz verwendet.
©2021 Lumileds Holding B.V. Alle Rechte vorbehalten.**

Lumileds is the warrantor of this product.
Philips and the Philips Shield Emblem are registered trademarks of
Koninklijke Philips N.V. and are used under license.
© 2021 Lumileds Holding B.V. All rights reserved.

