

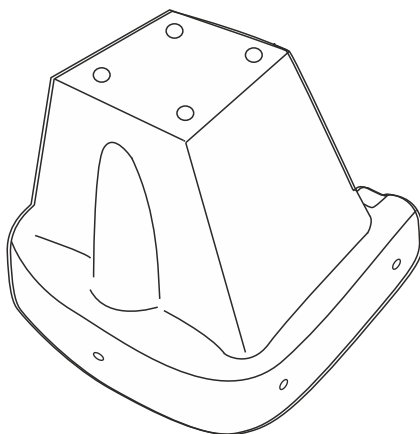

## KIA VENGA 2010-

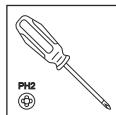

A

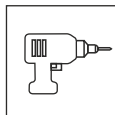
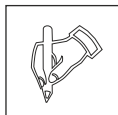
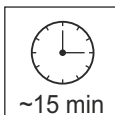
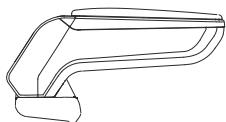

armster **S**

B

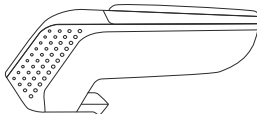

armster **2**

C

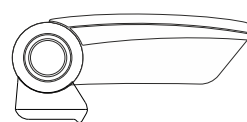

armster **3**

V1715



ABS

5x



St 4,8x16

1x



00195

