

Skoda Octavia (5E) 02/2013>

INBAY

WIRELESS CHARGING

CZ instalační návod

Úroveň obtížnosti

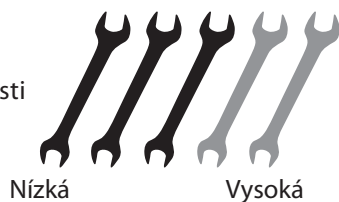

Nízká

Vysoká

SK Inštaláčny návod

Úroveň obtiažnosti

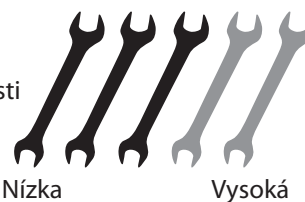

Nízka

Vysoká

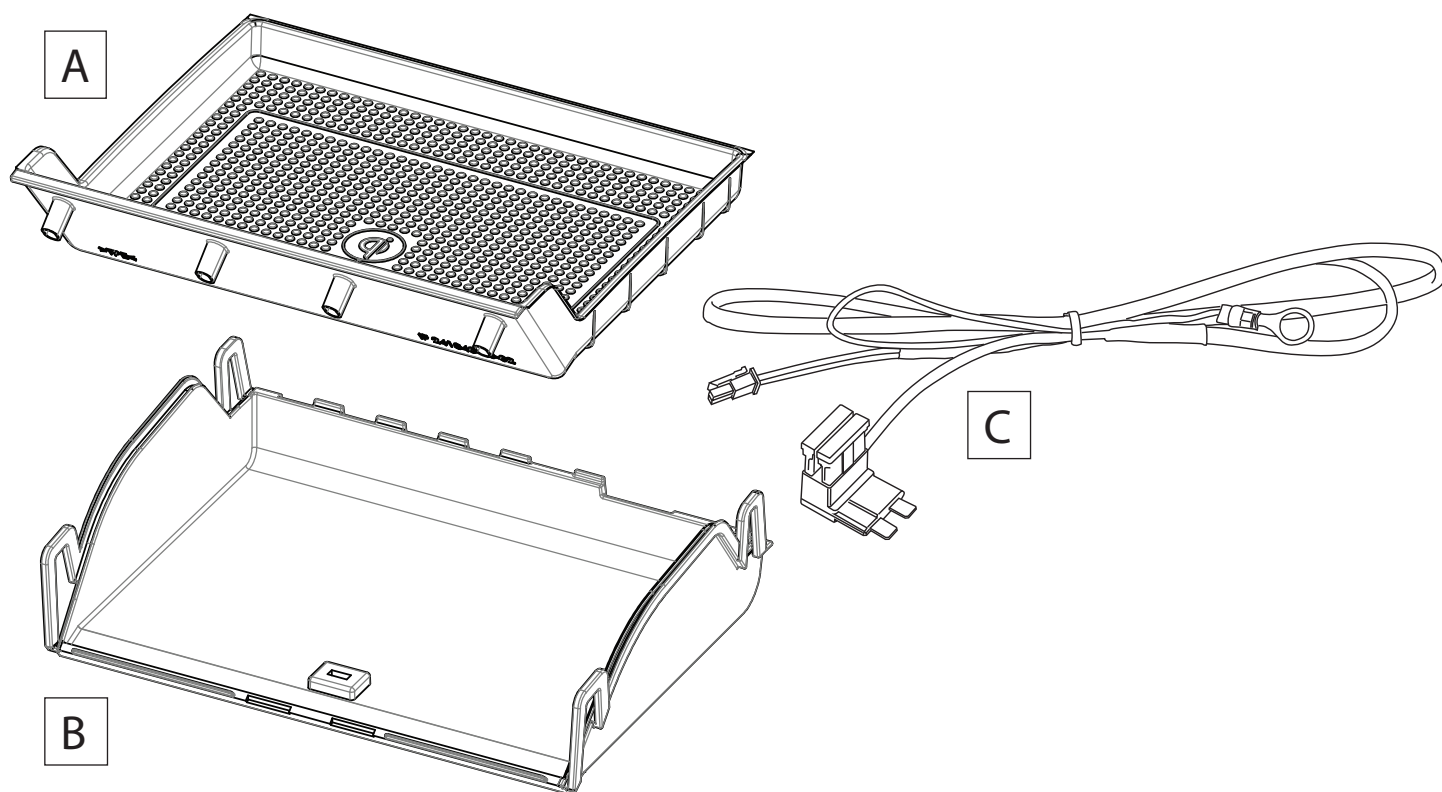

Inštaláčne video/Instalační video

<https://www.youtube.com/watch?v=RG8sl75bKrA>

Montáž je nezbytné provést v souladu s instrukcemi, které jsou uvedeny v tomto návodu. Ujistěte se, že kabely jsou uloženy tak, aby nebyly ohnuté ani přitisknuté, aby nedošlo k přerušení kabelu. Ujistěte se, že všechna připojení kabelů jsou správné. Uložte kabely mimo pohyblivé části. Nedovolte, aby kabel, který se má být uložen, byl smotaný, zlomený nebo jinak poškozený. Za škody způsobené nesprávnou instalací nebo používáním neručíme. Použijte specifikované části příslušenství, abyste předešli selhání produktu.

Vyhrazujeme si právo technické změny produktu bez předchozího upozornění.

Symbol "Qi" je ochranná známka společnosti "Wireless Power Consortium"

Montáž je nevyhnutné vykonať v súlade s inštrukciami ktoré sú uvedené v tomto návode. Uistite sa, že káble sú uložené tak, aby neboli ohnuté ani pritlačené, aby nedošlo k prerušeniu kábla. Uistite sa, že všetky pripojenia káblov sú správne. Uložte káble mimo pohyblivých častí, nedovoľte aby kábel, ktorý sa má byť uložený, bol zmotaný, zlomený alebo inak poškodený. Za škody spôsobené nesprávnou inštaláciou alebo používaním neručíme. Použite špecifikované časti príslušenstva, aby ste predišli zlyhaniu produktu.

Vyhrazujeme si právo technickej zmeny produktu bez predchádzajúceho upozornenia.

Symbol "Qi" je ochranná známka spoločnosti "Wireless Power Consortium"

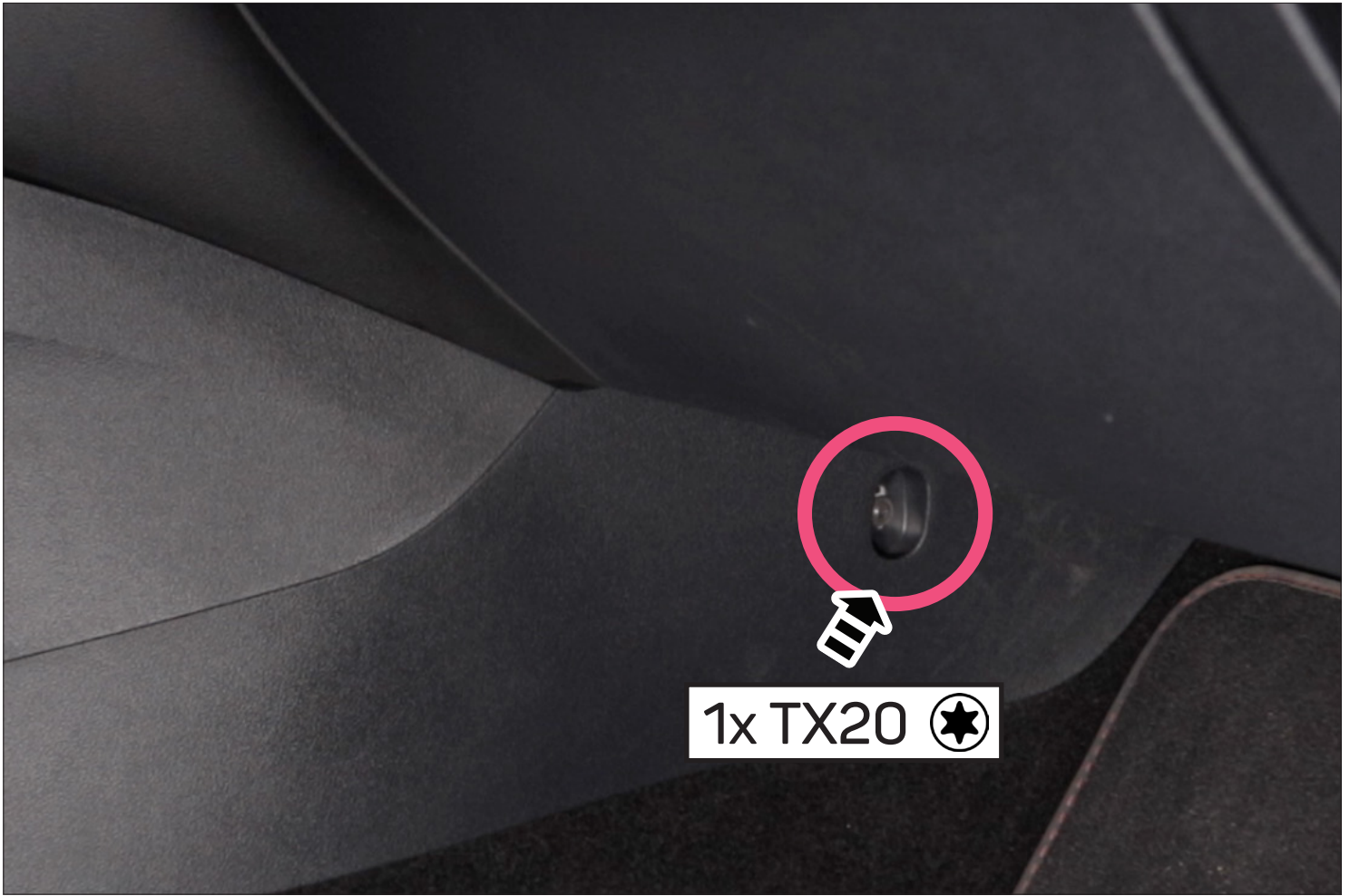

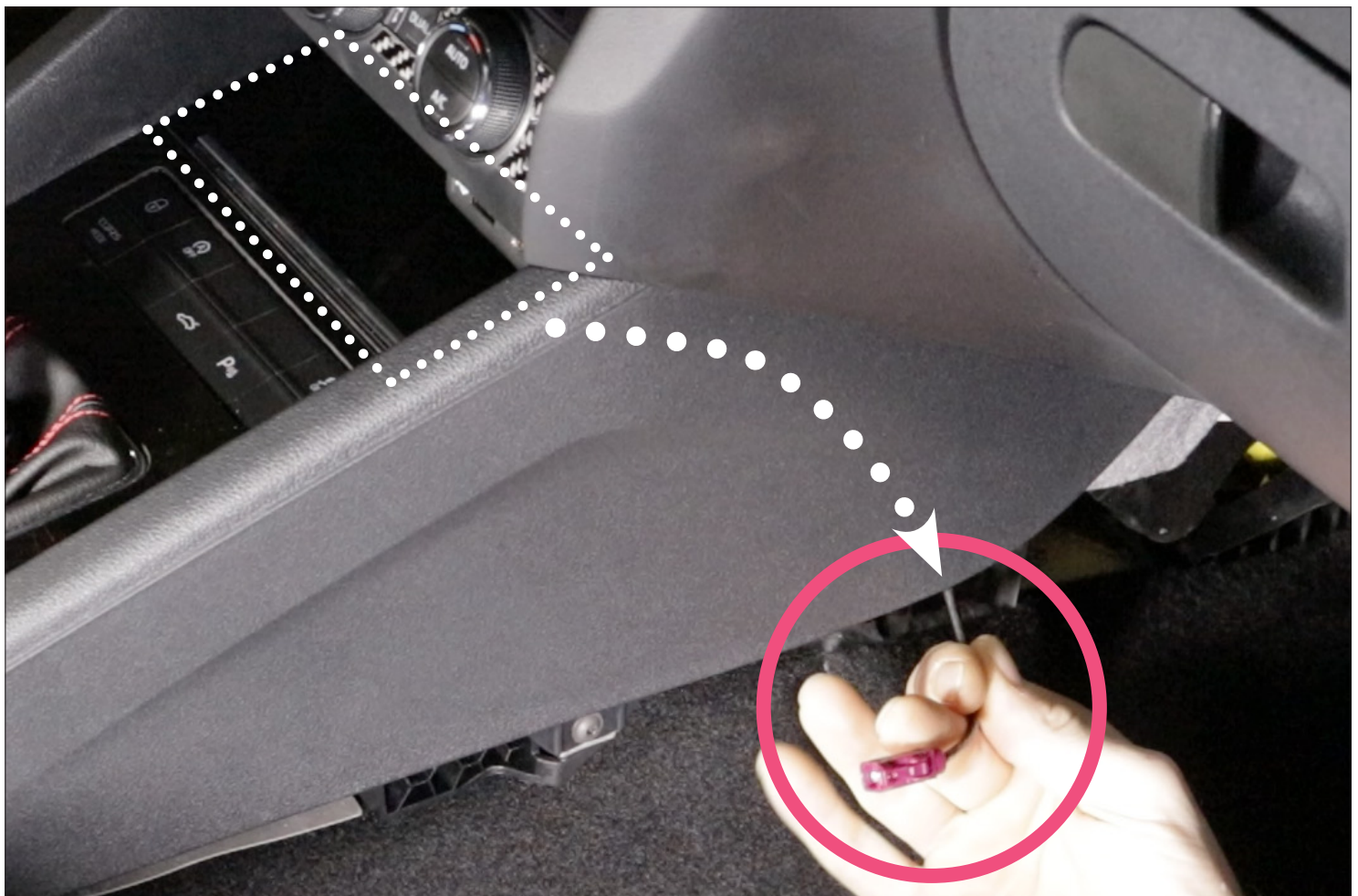
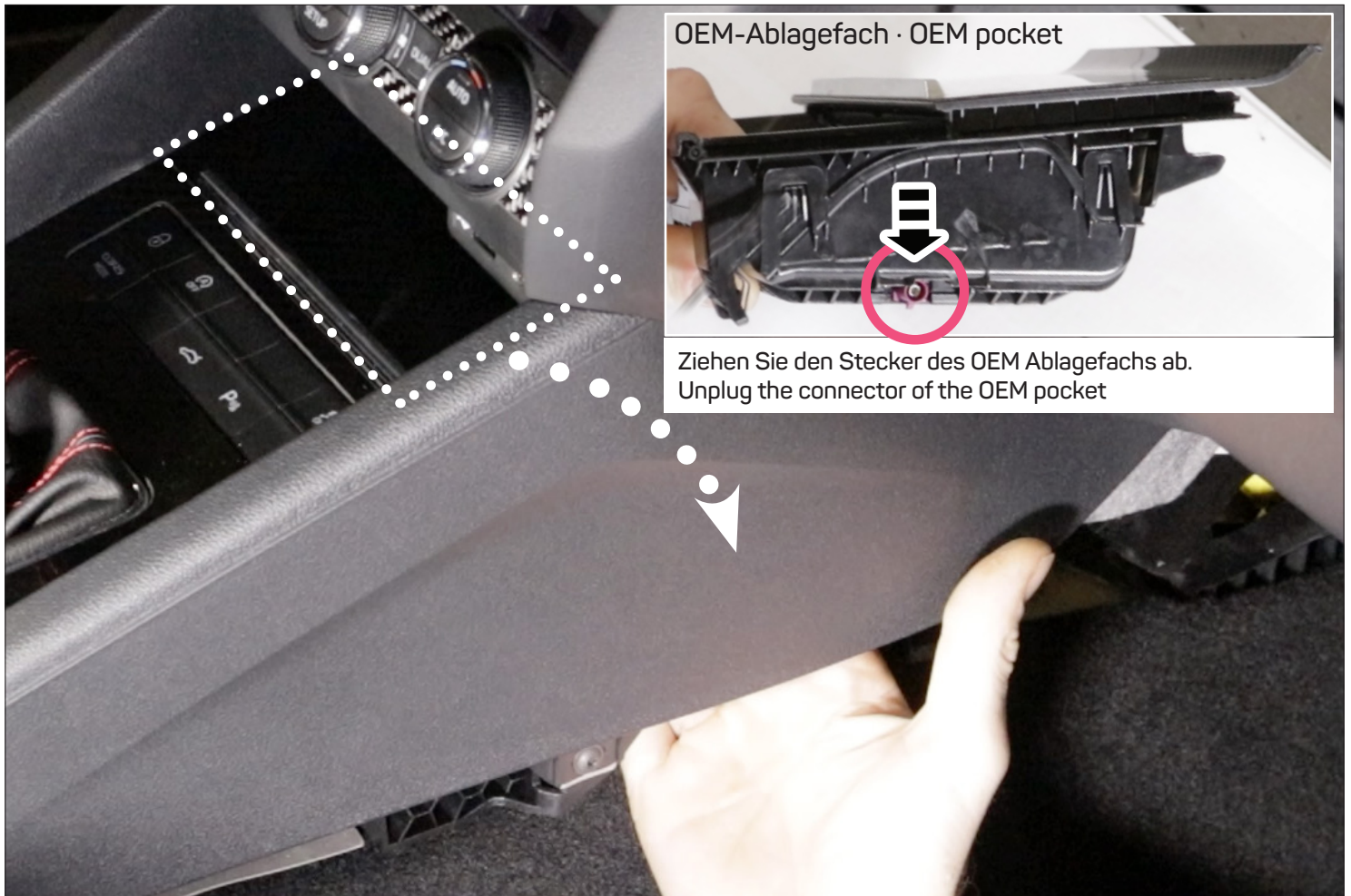

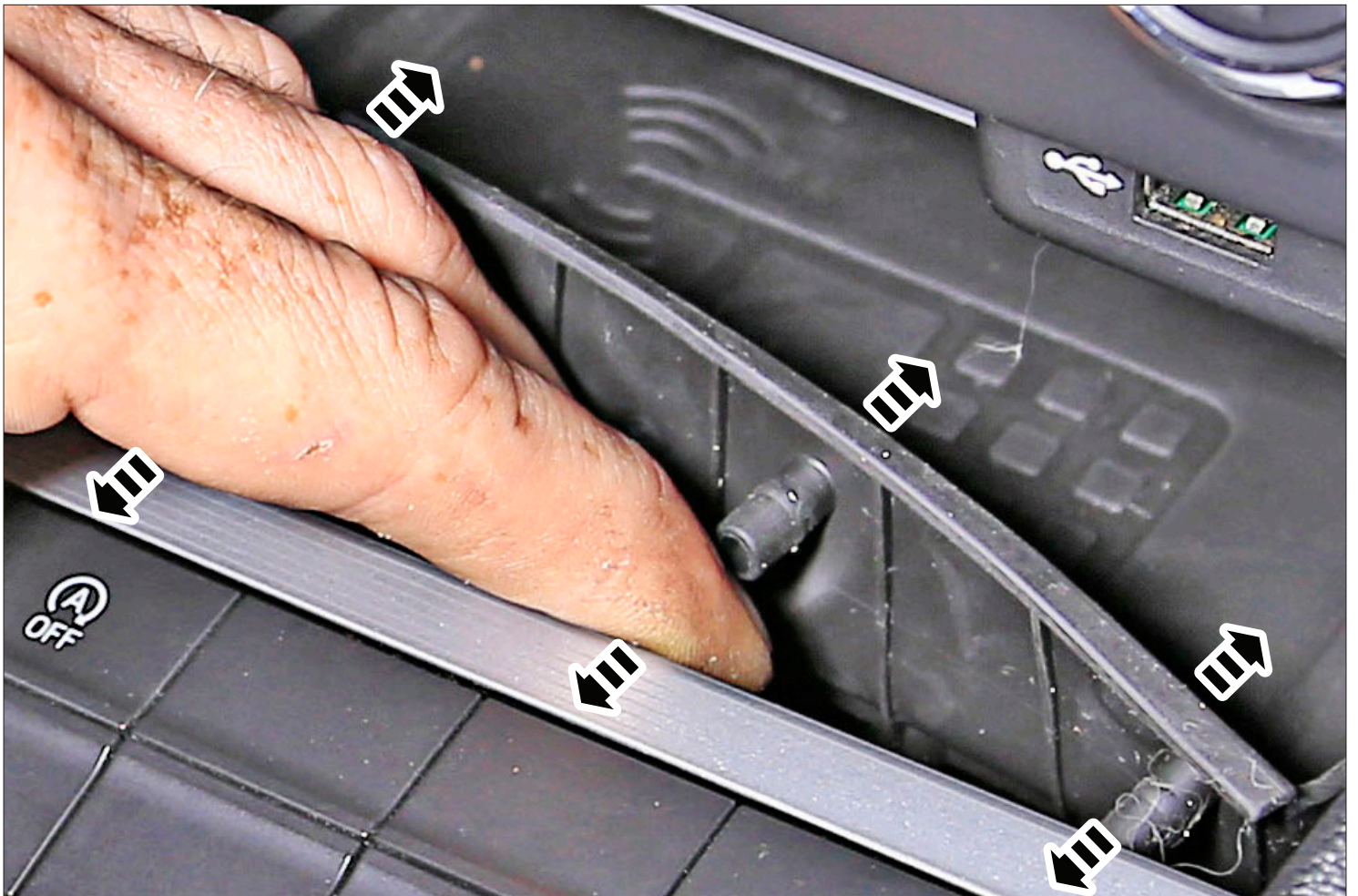



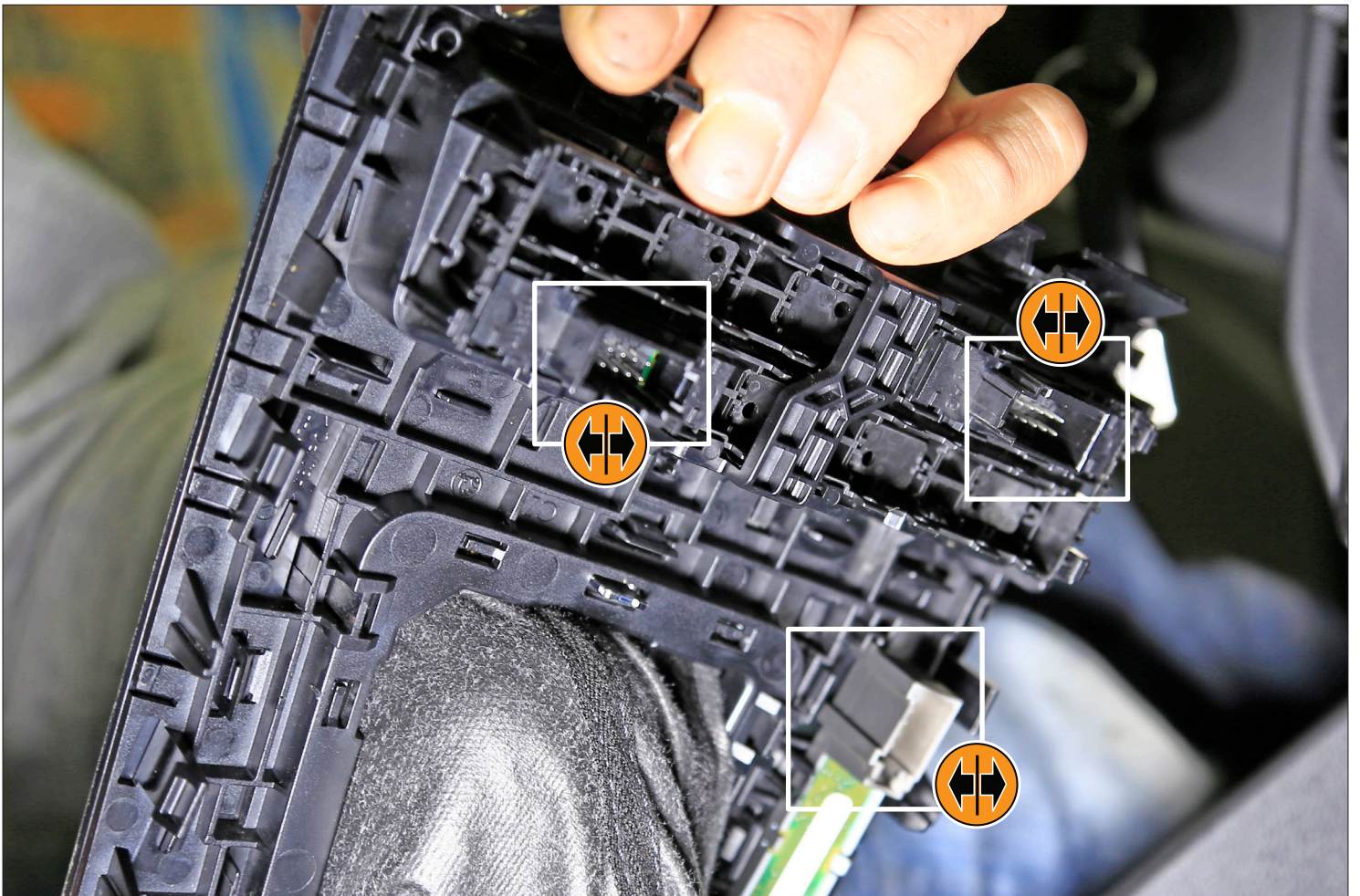

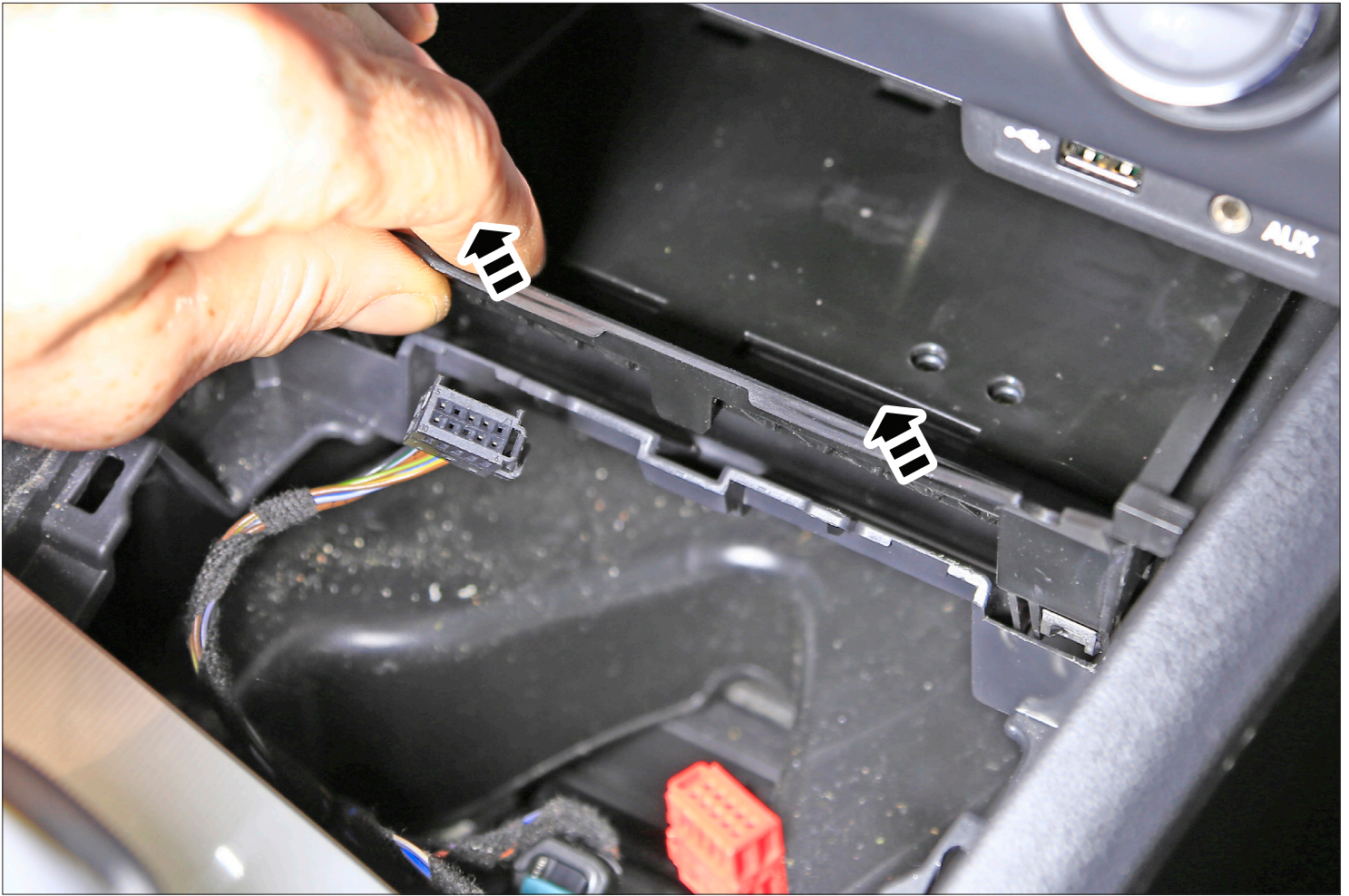

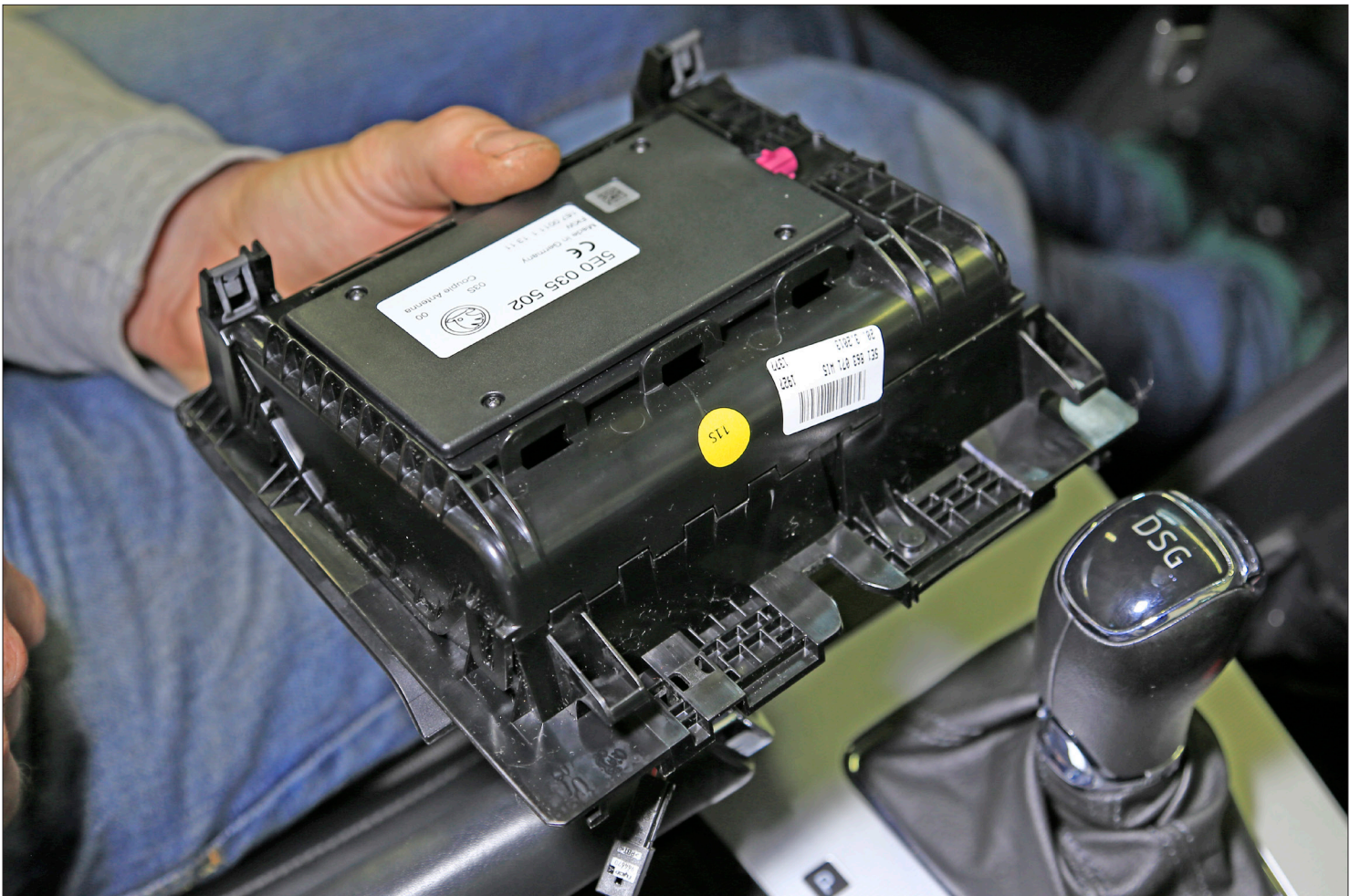



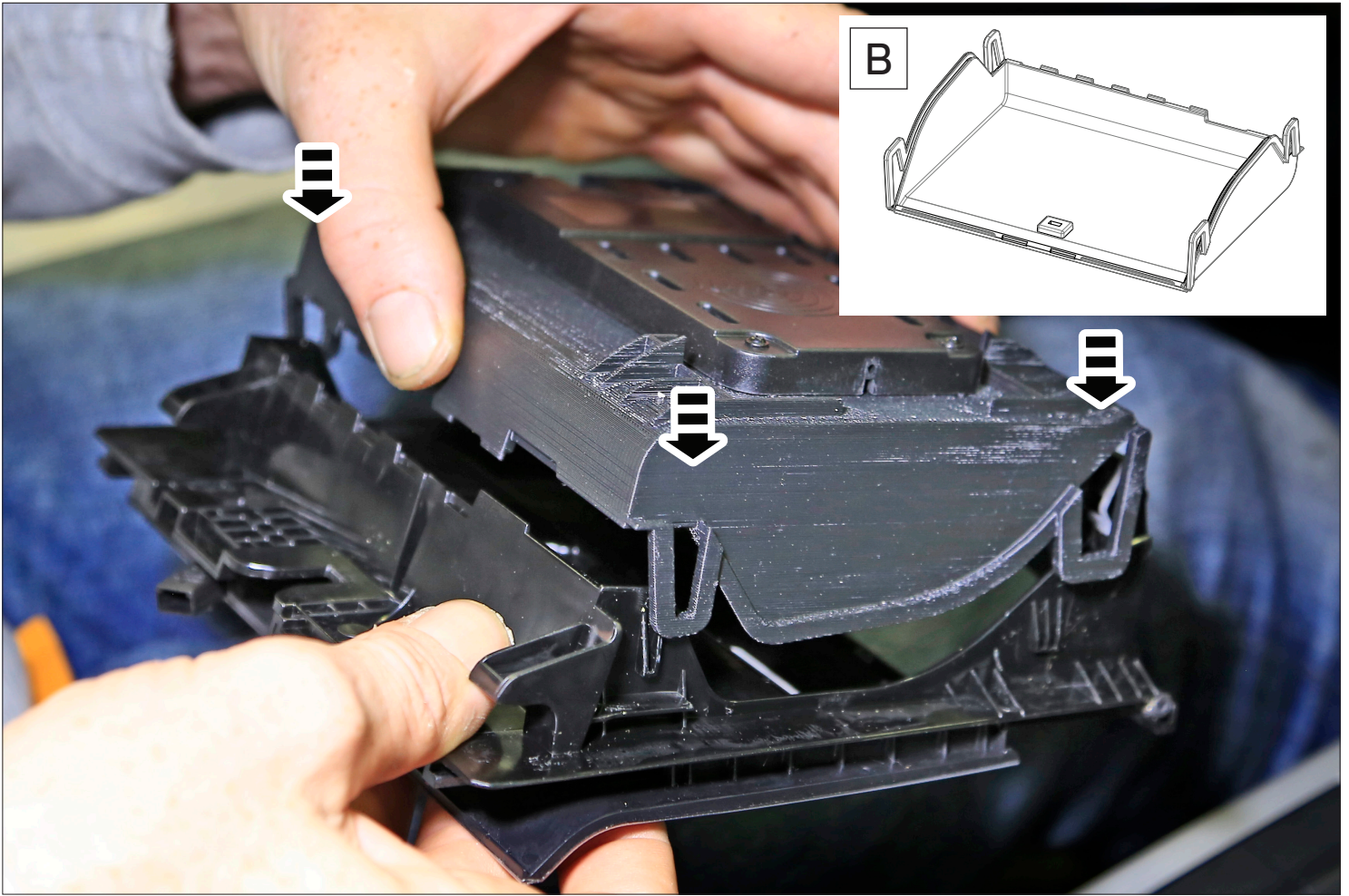



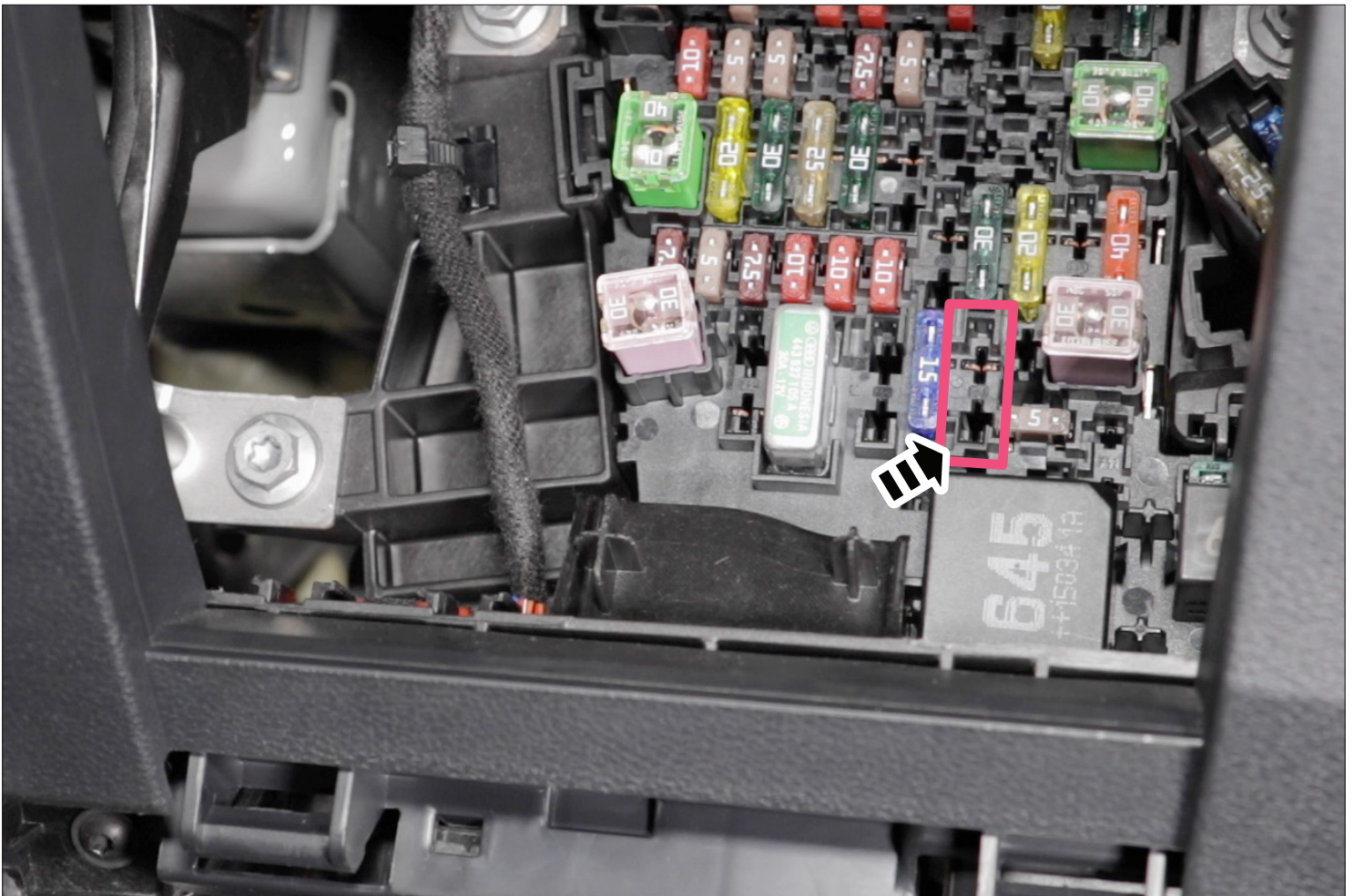

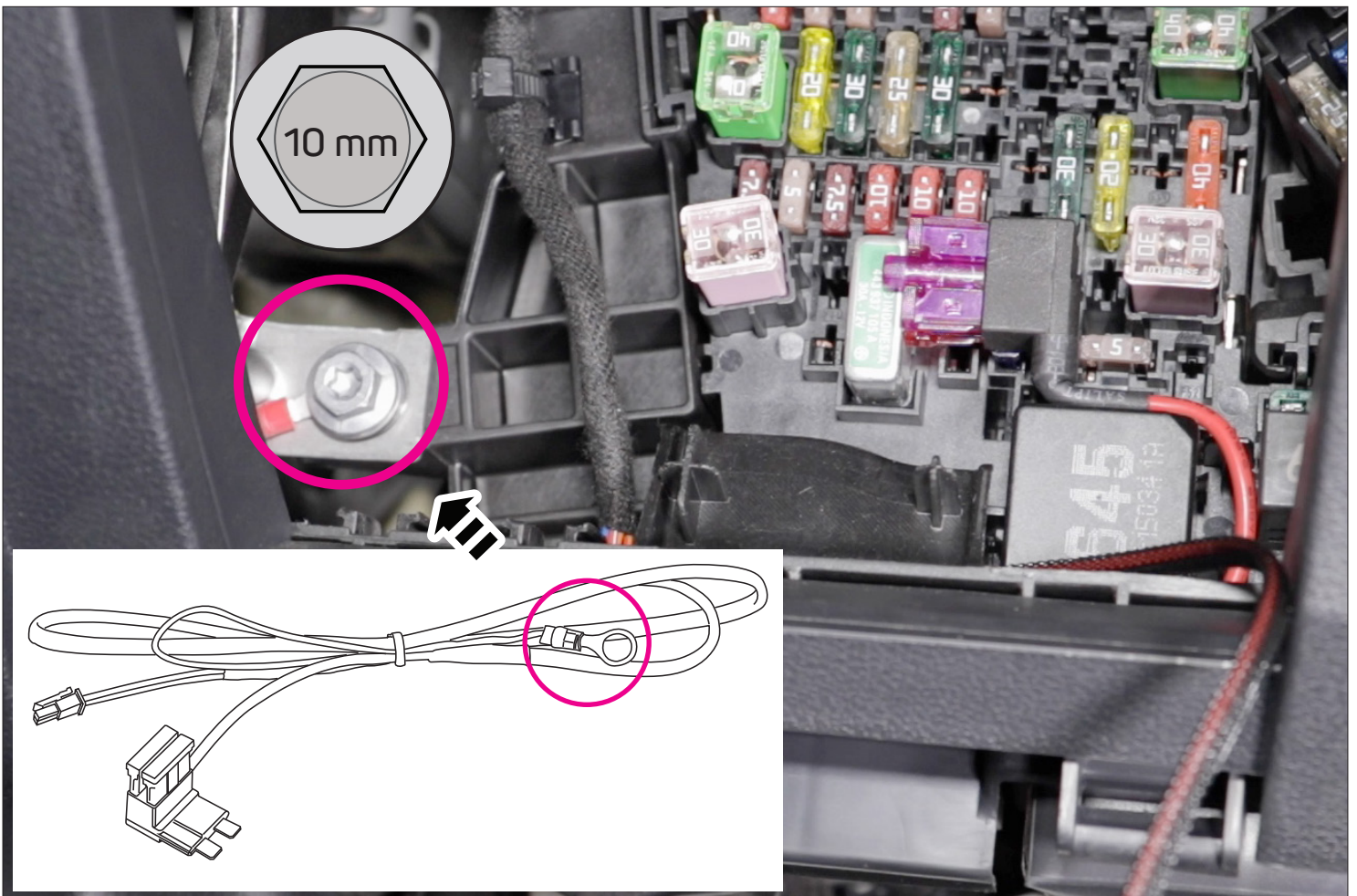
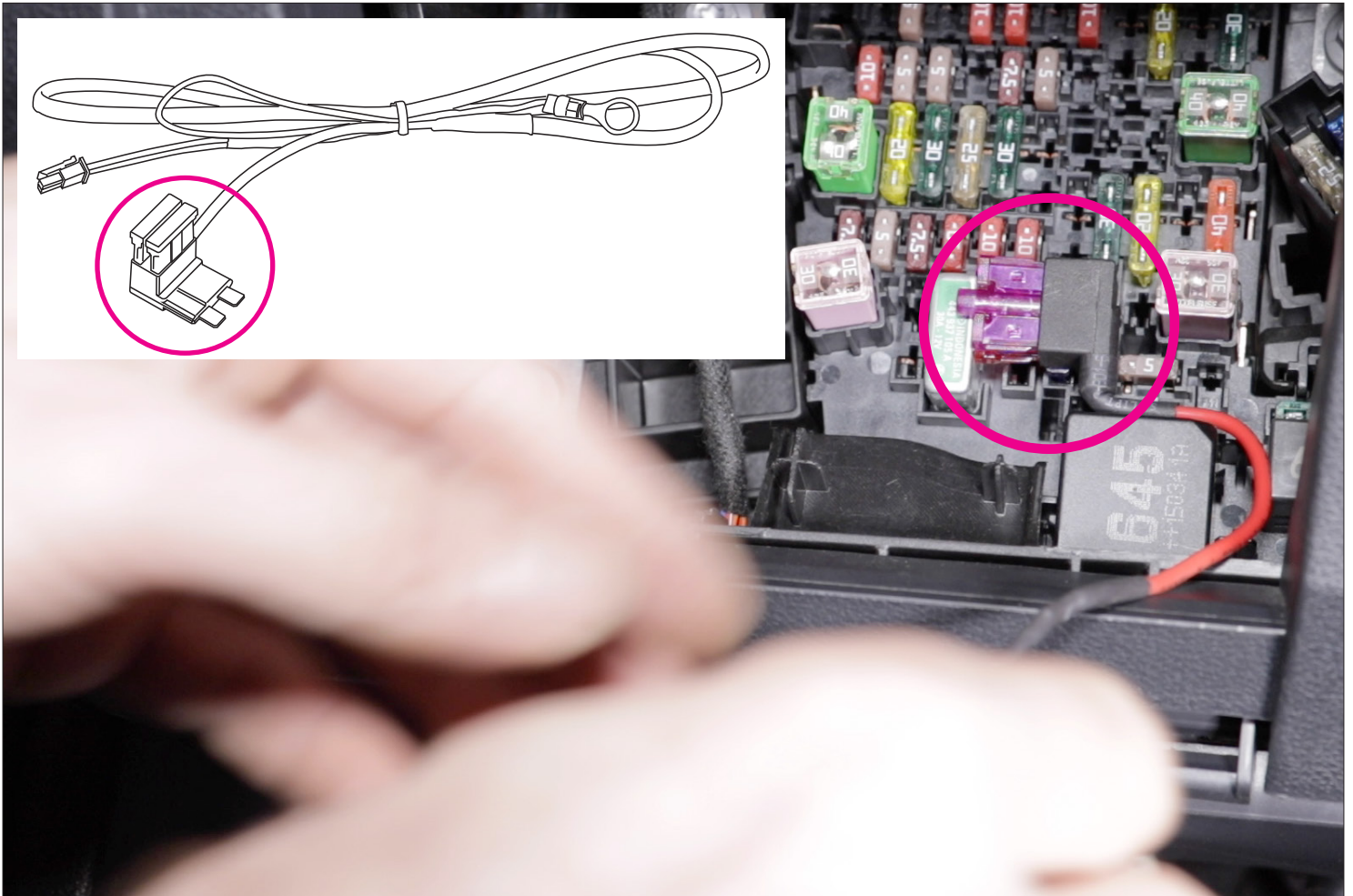

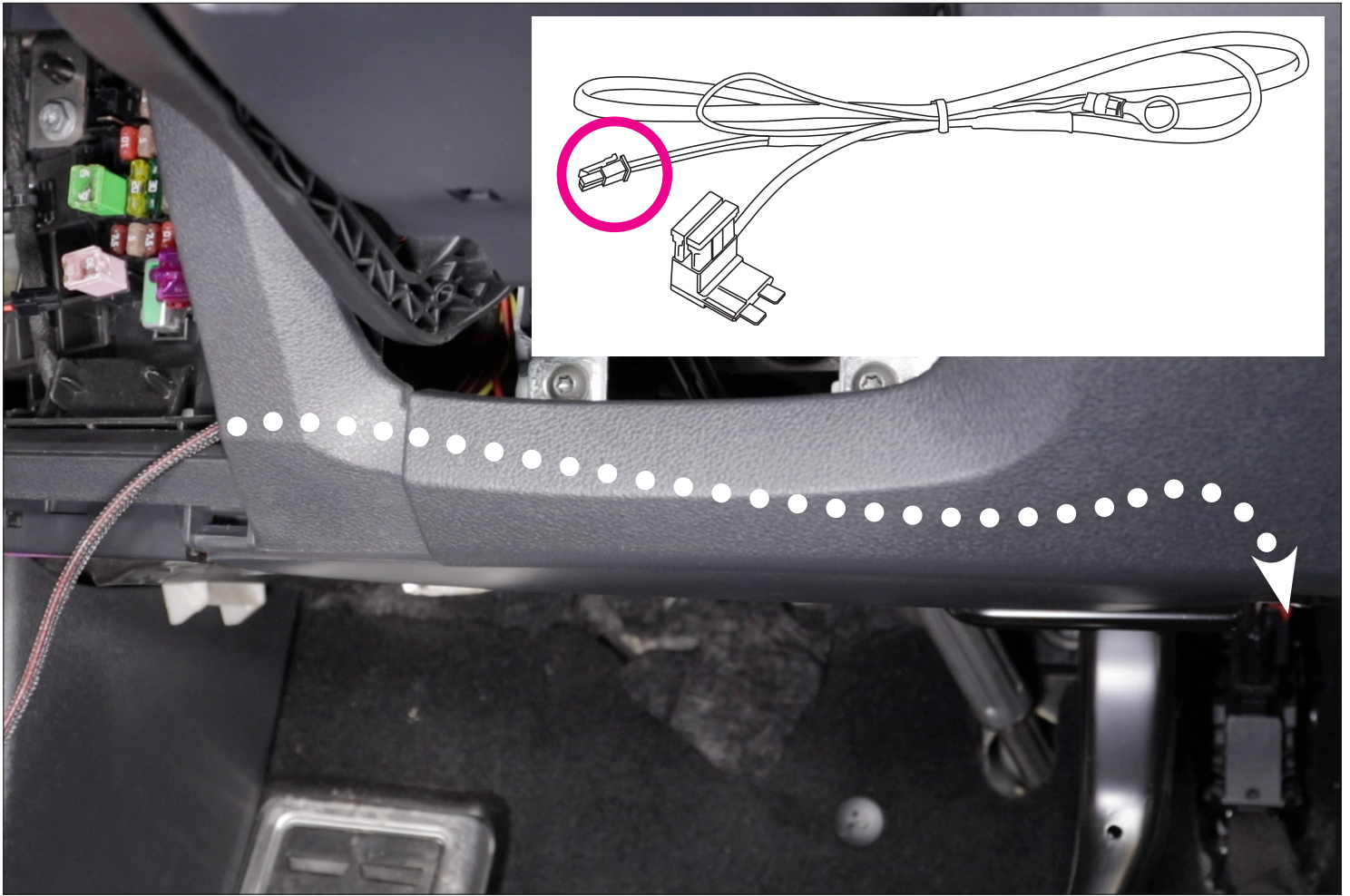

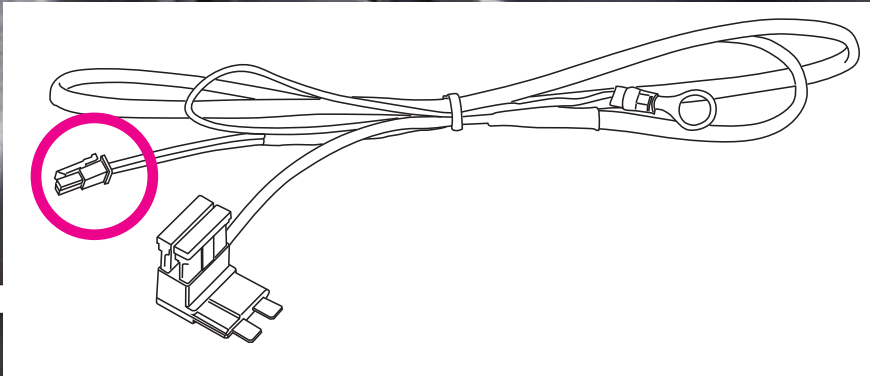



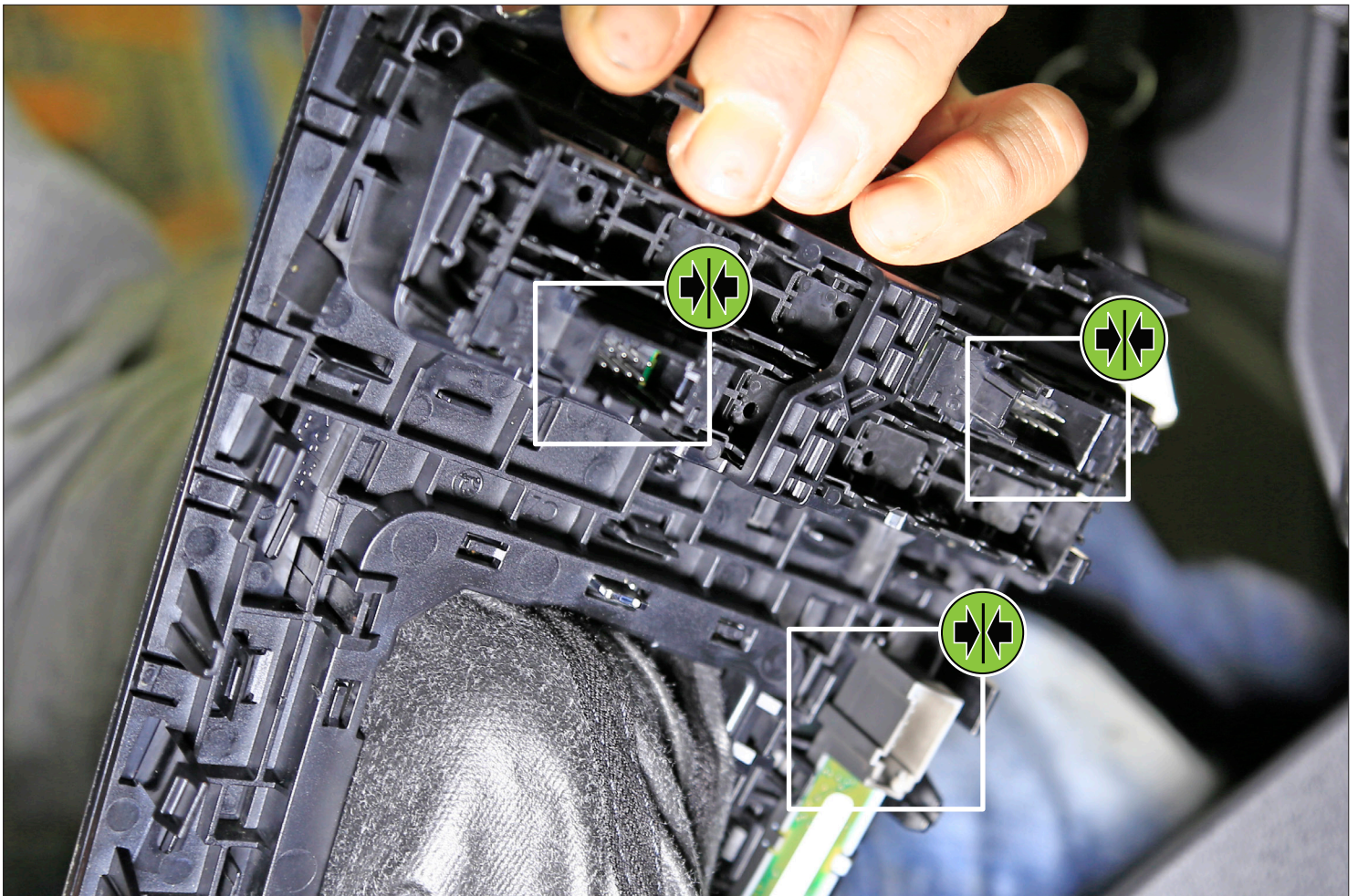
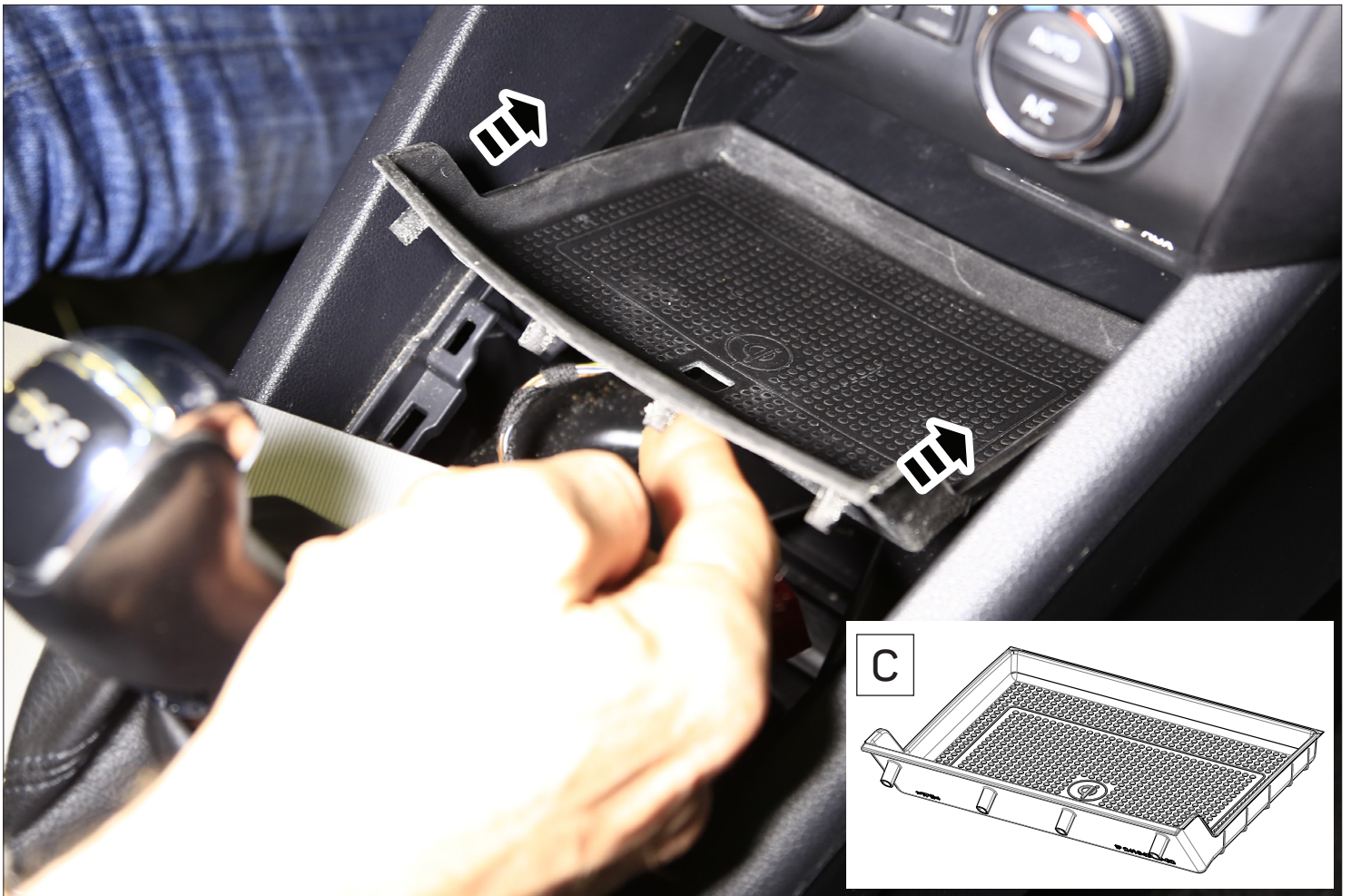





Modrá LED  

