

rati | armster adapter

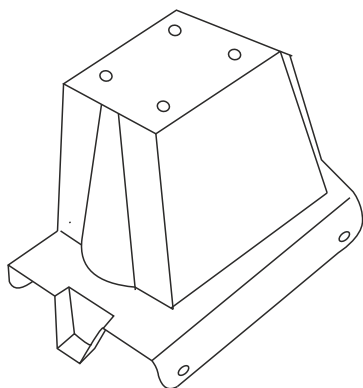

FIAT 500 2016- NOT FOR ELECTRIC MODELS (500e)

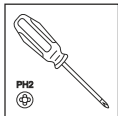
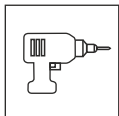
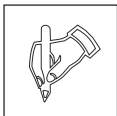
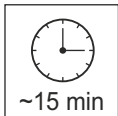

A

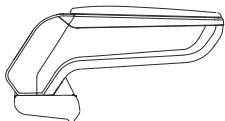

armster **S**

B

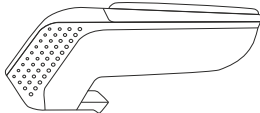

armster **2**

C

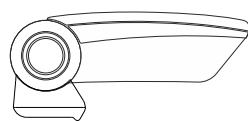

armster **3**

V01571



4x



St 4,8x16

1x



00417



A



armster 5

B



armster 2

C



armster 3

A/B/C

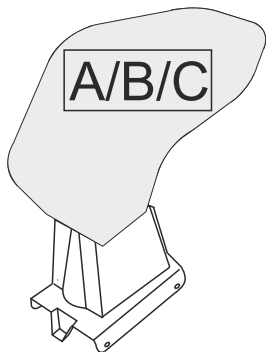

2

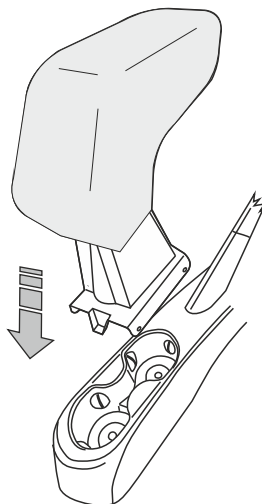

3

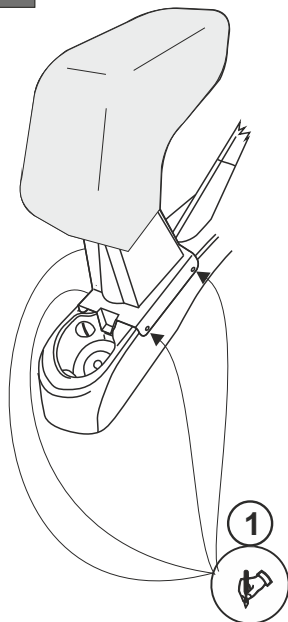

4

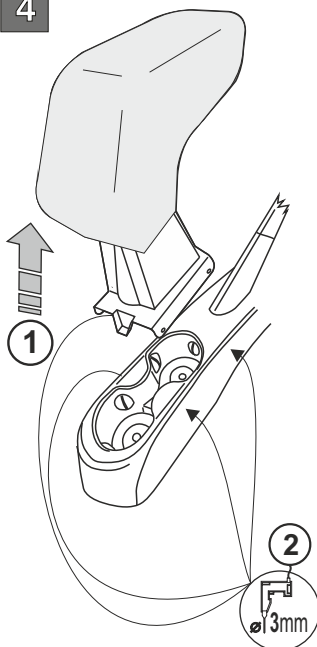

5

