

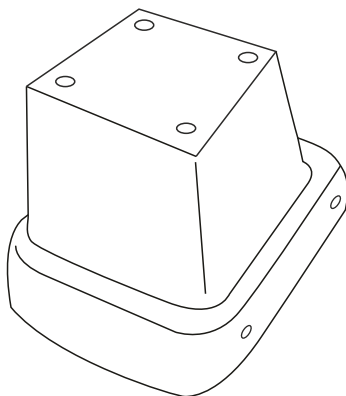

## OPEL AGILA 2008-2014

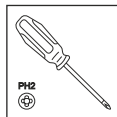

**A**

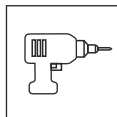
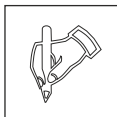
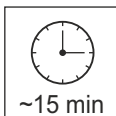
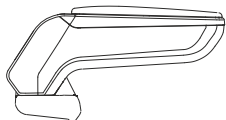

armster **S**

**B**

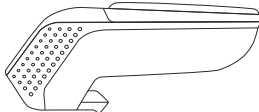

armster **2**

**C**

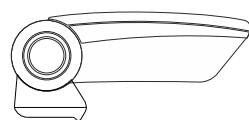

armster **3**

V01727



ABS

4x



St 4,8x16

1x



00177

